

Name: _____

Regents: January 2018

Common Core Geometry

Part I

1.		2.	
3.		4.	
5.		6.	
7.		8.	
9.		10.	
11.		12.	

13.	14.
15.	16.
17.	18.
19.	20.
21.	22.
23.	24.

Part II

25.

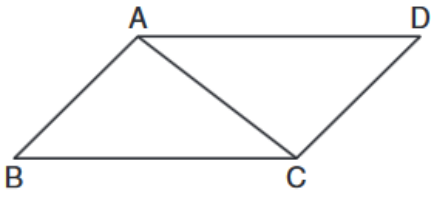

26.

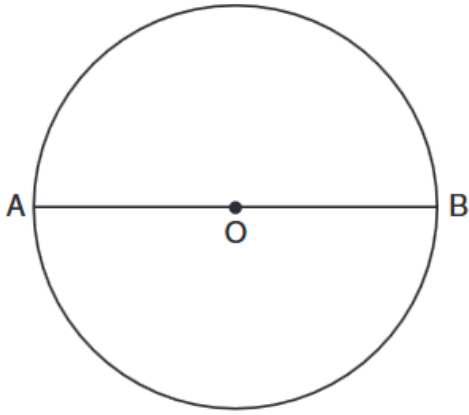

27.

28.

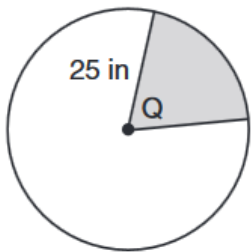

29.

30.

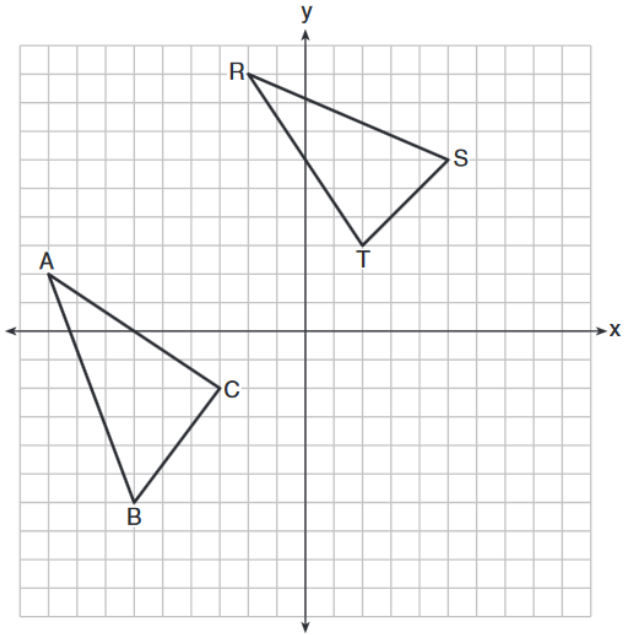

31.

32.

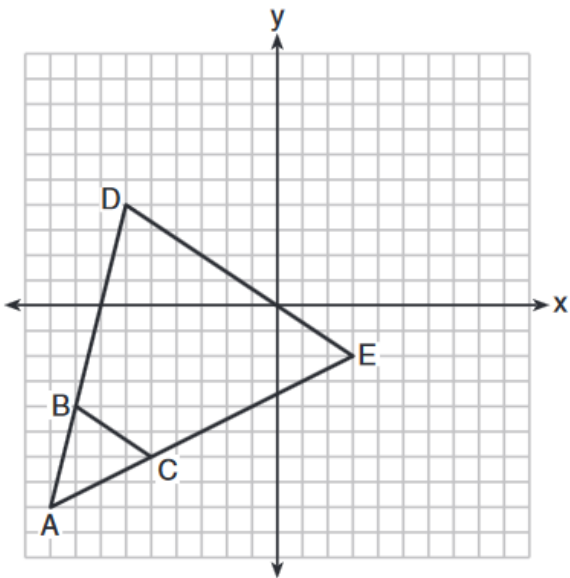

33.

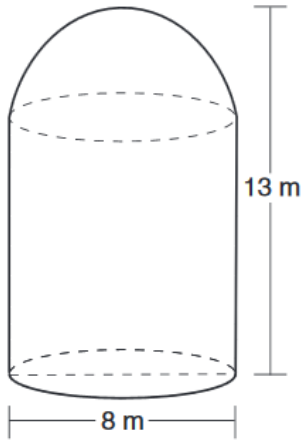

34.

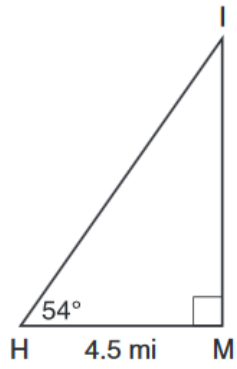

35.

